

* 1.6mm THICK FR4 (2 LAYER BOARD)

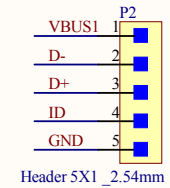
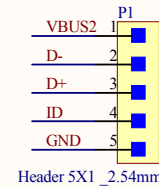
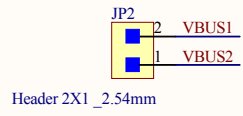
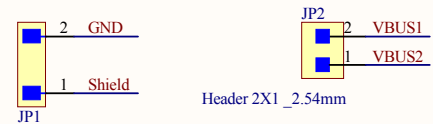
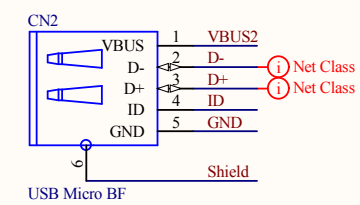
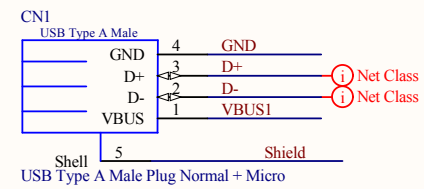
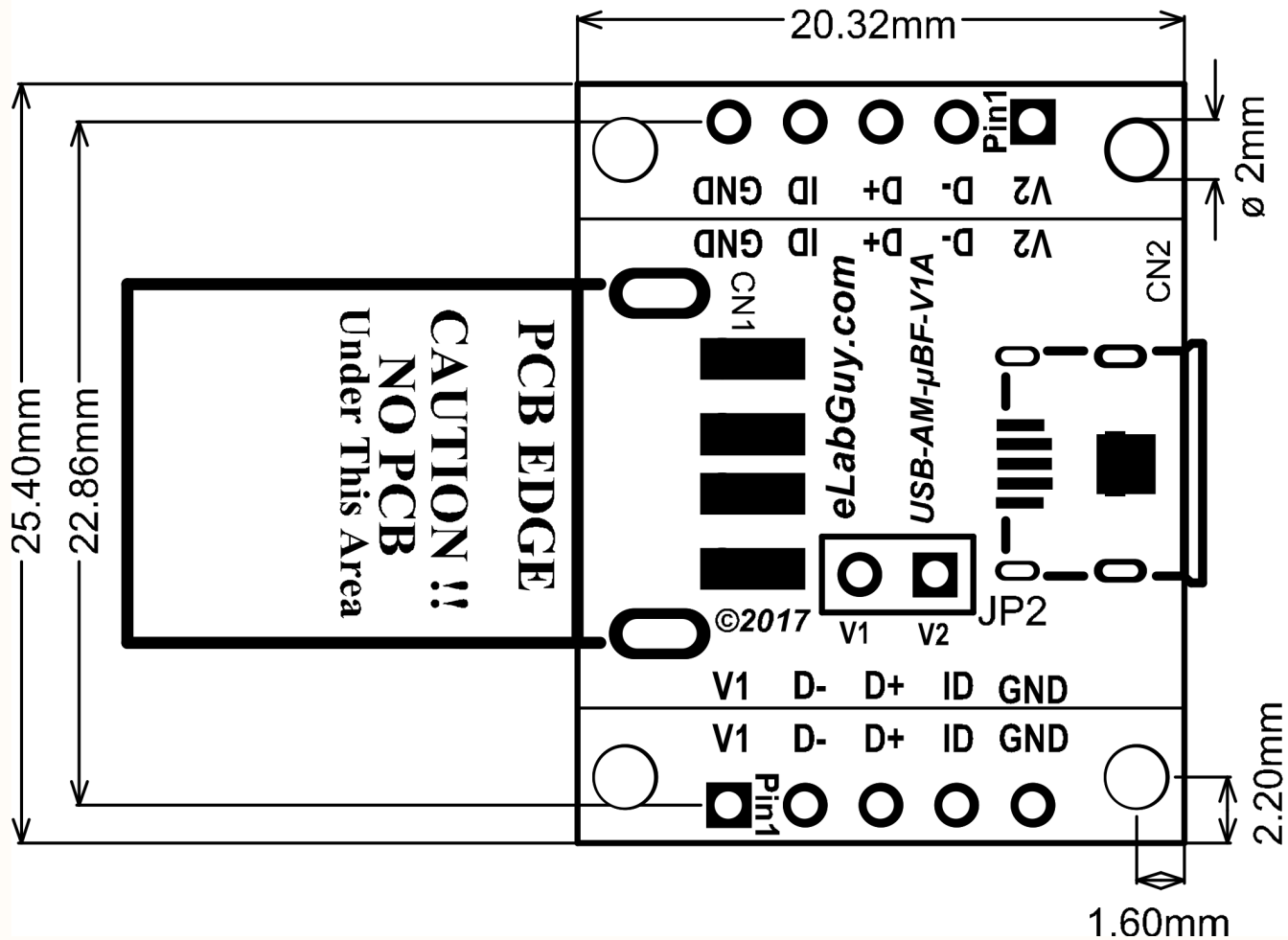

Title			USB2.0 Type A Male to Micro Type B Female Breakout		
Size	Number	Revision			
A4	USB-AM-μBF-V1A	1A			
Date:	9/6/2017	Sheet of			
File:	C:\Users\...USB-AM-μBF-V1A Drawing		Sheet By:	www.eLabGuy.com	